

Product Description

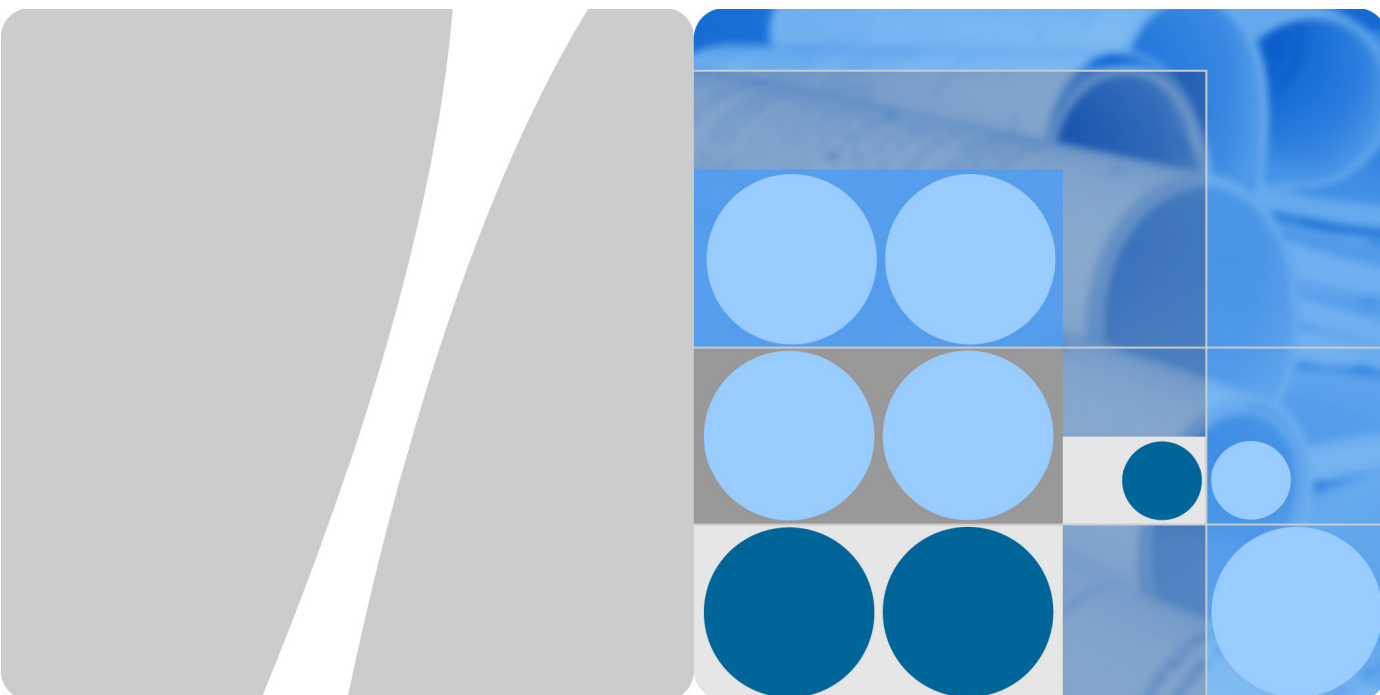

HUAWEI E5186s-22a LTE CPE
V200R001

Issue 02
Date 2014-03-26

Huawei Technologies Co., Ltd. provides customers with comprehensive technical support and service. Please feel free to contact our local office or company headquarters.

Huawei Technologies Co., Ltd.

Address: Huawei Industrial Base
Bantian, Longgang
Shenzhen 518129
People's Republic of China

Website: <http://consumer.huawei.com/en/>

Copyright © Huawei Technologies Co., Ltd. 2014. All rights reserved.

No part of this document may be reproduced or transmitted in any form or by any means without prior written consent of Huawei Technologies Co., Ltd.

Trademarks and Permissions



and other Huawei trademarks are trademarks of Huawei Technologies Co., Ltd.

All other trademarks and trade names mentioned in this document are the property of their respective holders.

Notice

The information in this document is subject to change without notice. Every effort has been made in the preparation of this document to ensure accuracy of the contents, but all statements, information, and recommendations in this document do not constitute a warranty of any kind, express or implied.

About This Document

Purpose

This document describes the main functions, supported services, and system architecture of the HUAWEI E5186s-22a Long Term Evolution (LTE) Customer-Premises Equipment (CPE) V200R001 (E5186s-22a for short).

This document is organized as follows.

Chapter	Description
1 Overview	Supported network modes, basic services and functions, and appearance of the E5186s-22a.
2 Product Features	Features and technical specifications of the E5186s-22a.
3 Services and Applications	Services provided by the E5186s-22a.
4 System Architecture	System architecture of the E5186s-22a.
5 Packing List	Items included with the E5186s-22a.

Change History

Version	Change Description	Date
01	First release	2013-12-17
02	<ul style="list-style-type: none">• Change the frequency bands of LTE• Change the maximum transmission rate of LTE TDD downlink packet data service from 110 Mbit/s to 220 Mbit/s• Modify the maximum transmit power of WLAN• Modify the system architecture diagram• Delete “External Antenna” in table 5-1	2014-03-26

Contents

About This Document	3
1 Overview	6
2 Product Features	8
2.1 Main Features.....	8
2.2 Technical Specifications	9
2.2.1 Hardware Specifications.....	9
2.2.2 Antenna Specifications	11
2.2.3 Software Specifications	12
3 Services and Applications.....	15
3.1 Data Services	15
3.1.1 Accessing the Internet Using an LTE, UMTS, or GSM Network	15
3.1.2 Accessing the Internet Using Ethernet.....	16
3.2 Voice Services.....	16
3.3 USB Sharing Services.....	18
3.4 Security Services	18
3.4.1 Firewall.....	18
3.4.2 User Authentication.....	19
3.4.3 PIN Protection.....	19
3.5 Maintenance and Management.....	19
4 System Architecture.....	20
4.1 System Architecture Diagram.....	20
4.2 Functional Modules	20
5 Packing List.....	22

1 Overview

As a high-performance LTE CPE device, the E5186s-22a enables users to get access to wireless and wired networks. The E5186s-22a supports the following frequency bands:

- LTE
 - Frequency division duplex (FDD): 2600/2100/1800/900/800 MHz
 - FDD Down Link (DL) Carrier Aggregation (CA): 1800 MHz + 2600 MHz, 1800 MHz + 800 MHz, 2600 MHz + 800 MHz, 1800 MHz intra-band contiguous, 2600 MHz intra-band contiguous
 - Time division duplex (TDD): 2600 MHz
 - TDD DL CA: 2600 MHz intra-band contiguous
- DC-HSPA+/HSPA+/HSPA/UMTS: 2100/900 MHz
- EDGE/GPRS/GSM: 1900/1800/900/850 MHz

The E5186s-22a can work in any of the following network standards:

- LTE
- Dual Carrier High Speed Packet Access Plus (DC-HSPA+)
- High Speed Packet Access Plus (HSPA+)
- High Speed Uplink Packet Access (HSUPA)
- High Speed Downlink Packet Access (HSDPA)
- Universal Mobile Telecommunications System (UMTS)
- Enhanced Data Rates for Global Evolution (EDGE)
- General Packet Radio Service (GPRS)
- Global System for Mobile Communications (GSM)

The E5186s-22a provides the following services and functions:

- Data services
- Voice services
- Short message service (SMS)
- USB Sharing services
- Security functions
- Maintenance and management

Figure 1-1 shows the appearance of the E5186s-22a.

Figure 1-1 E5186s-22a appearance



2 Product Features

2.1 Main Features

The following lists the main features of the E5186s-22a:

- Access to LTE/DC-HSPA+/HSPA+/HSPA/UMTS/EDGE/GPRS/GSM wireless networks
- Access to wired Ethernet networks
- LTE FDD downlink packet data service at a maximum transmission rate of 300 Mbit/s (theoretical value)
- LTE FDD uplink packet data service at a maximum transmission rate of 50 Mbit/s (theoretical value)
- LTE TDD downlink packet data service at a maximum transmission rate of 220 Mbit/s (theoretical value)
- LTE TDD uplink packet data service at a maximum transmission rate of 10 Mbit/s (theoretical value)
- DC-HSPA+ downlink packet data service at a maximum transmission rate of 43.2 Mbit/s (theoretical value)
- HSPA+ downlink packet data service at a maximum transmission rate of 21.6 Mbit/s (theoretical value)
- HSPA downlink packet data service at a maximum transmission rate of 14.4 Mbit/s (theoretical value)
- HSPA uplink packet data service at a maximum transmission rate of 5.76 Mbit/s (theoretical value)
- UMTS packet data service at a maximum transmission rate of 384 kbit/s (theoretical value)
- UMTS circuit-switched data service at a maximum transmission rate of 64 kbit/s (theoretical value)
- EDGE packet data service at a maximum transmission rate of 236.8 kbit/s (theoretical value)
- GPRS packet data service at a maximum transmission rate of 85.6 kbit/s (theoretical value)
- IEEE802.11a/b/g/n/ac
- Wi-Fi 2.4 GHz and 5 GHz bands
- LAN/WAN autonegotiation Ethernet port

- Gigabit Ethernet port
- Support for HUAWEI Mobile WiFi App
- Functioning as a Dynamic Host Configuration Protocol (DHCP) server and supporting Network Address Translation (NAT)
- Internet Protocol version 6 (IPv6)/Internet Protocol version 4 (IPv4) dual stack
- Wi-Fi and Wi-Fi protected setup (WPS)
- Windows XP SP3, Windows Vista SP1/SP2, Windows 7, Windows 8, Windows 8.1, Mac OS X 10.7, 10.8, and 10.9 with latest upgrades
- LTE/UMTS/GSM external antenna ports
- USB 2.0 host port
- Personalized light emitting diode (LED) indicators

2.2 Technical Specifications

2.2.1 Hardware Specifications

Table 2-1 lists the hardware specifications of the E5186s-22a.

Table 2-1 Hardware specifications

Item	Description
Technical standards	WAN: LTE/DC-HSPA+/HSPA+/HSPA/UMTS/EDGE/GPRS/GSM
	LAN: IEEE 802.3/802.3u
	WLAN: IEEE 802.11 a/b/g/n/ac
Working bands	LTE: <ul style="list-style-type: none"> • FDD 2600/2100/1800/900/800 MHz • FDD DL CA 1800 MHz + 2600 MHz, 1800 MHz + 800 MHz, 2600 MHz + 800 MHz, 1800 MHz intra-band contiguous, 2600 MHz intra-band contiguous • TDD 2600 MHz • TDD DL CA 2600 MHz intra-band contiguous
	DC-HSPA+/HSPA+/HSPA/UMTS: 2100/900 MHz
	EDGE/GPRS/GSM: 1900/1800/900/850 MHz
	WLAN: 2.4GHz, 5GHz (indoor use only)
Memory	128 MB NAND Flash 128 MB Double Data Rate (DDR) Synchronous Dynamic Random Access Memory (SDRAM)
External ports	One power port
	Two RJ11 ports for telephone connections
	Three gigabit Ethernet RJ45 ports for LAN connections

Item	Description	
	One gigabit Ethernet RJ45 port for both LAN and WAN connections	
	One USB 2.0 host port	
	One micro subscriber identity module (SIM) card port	
	Two external antenna ports	
Buttons	One power switch	
	One Wi-Fi button	
	One WPS button	
	One RESET button	
LED indicators	One POWER indicator	
	One Wi-Fi indicator	
	One VOICE indicator	
	One MODE indicator	
	One signal strength indicator	
	Three LAN indicators	
	One LAN/WAN indicator	
Maximum transmit power	LTE: Conform to Power Class 3 Definition	
	UMTS: Conform to Power Class 3 Definition	
	WLAN	802.11a: 17 dBm
		802.11b: 16 dBm
		802.11g: 16 dBm
		802.11n: 16 dBm
		802.11ac: 17 dBm
Receiving sensitivity	LTE: Confirm to 3GPP Requirements	
	UMTS: Confirm to 3GPP Requirements	
	WLAN	802.11a: -65 dBm at 54 Mbit/s
		802.11b: -76 dBm at 11 Mbit/s
		802.11g: -65 dBm at 54 Mbit/s
		802.11n: -64 dBm at 65 Mbit/s
		802.11ac: -59 dBm at 78 Mbit/s

Item	Description
Power consumption	< 20 W
Power supply	AC: 100–240 V
	DC: 12 V/2 A
Dimensions (H x W x D)	190 mm × 200 mm × 32 mm
Weight	About 550 g
Temperature	Working temperature: 0°C to +40°C
	Storage temperature: –20°C to +70°C
Humidity	5%–95% RH

2.2.2 Antenna Specifications

Table 2-2 Specifications of the LTE main antenna

Item	Description
Frequency range	790–2690 MHz
Input impedance	50 Ω
Standing wave ratio (SWR)	< 3
Efficiency	> 50%
Gain	0–3 dBi
Polarization type	Linear polarization

Table 2-3 Specifications of the WLAN antenna at 2.4 GHz

Item	Description
Frequency range	2.4–2.483 GHz
Input impedance	50 Ω
SWR	< 3
Efficiency	> 50%
Gain	< 2.5 dBi
Polarization type	Linear polarization

Table 2-4 Specifications of the WLAN antenna at 5 GHz

Item	Description
Frequency range	5–6 GHz
Input impedance	50 Ω
SWR	< 3
Efficiency	> 50%
Gain	< 3.5 dBi
Polarization type	Linear polarization

2.2.3 Software Specifications

Table 2-5 lists the software specifications of the E5186s-22a.

Table 2-5 Software specifications

Item	Description	
Gateway	Supports the default route: 0.0.0.0	
	Supports the default gateway address: 192.168.8.1	
	Supports the Address Resolution Protocol (ARP).	
	Supports the Internet Control Message Protocol (ICMP).	
	Supports the domain name service (DNS).	
	Supports the Digital Living Network Alliance (DLNA)	
	Supports Samba sharing	
	Supports external USB storage devices and USB printer	
	NAT	Supports NAT and Network Address and Port Translation (NAPT), which complies with RFC2663, RFC3022, and RFC3027.
		Supports CONE NAT
Supports fragmented message identification during common NAT.		
DHCP server	Enables and disables the DHCP server.	
	Configures DHCP server address pools.	
	Sets the lease time.	
	Displays the status of the DHCP server address pools, including host names, Media Access Control (MAC) addresses, IP addresses, and remaining lease time.	

Item	Description	
SMS	Writing/Sending/Receiving	
	Writing/Sending/Receiving extra-long messages	
Voice and fax	VoIP	Supports the Session Initiation Protocol (SIP)
		Supports G.711a, G.711u, G.729a, G.729b, G.726 (-24/-32), G.722, and G.723.1 for encoding and decoding
	CS voice	Supports CS voice communication over UMTS and GSM networks
		Supports the circuit switched fallback (CSFB)
	Fax	T.38 fax
Fax pass through		
Firewall	Enables and disables the firewall.	
	Filters LAN MAC addresses.	
	Filters LAN IP addresses.	
	Filters URLs.	
	Supports demilitarized zone (DMZ).	
	Supports Universal Plug and Play (UPnP).	
	Supports Application Level Gateway (ALG).	
WLAN	Broadcasts and hides service set identifiers (SSIDs).	
	Complies with IEEE 802.11a/b/g/n/ac.	
	Supports WPS.	
	Authentication	Supports OpenSystem authentication.
		Supports encryption using wired equivalent privacy (WEP), Wi-Fi protected access preshared key (WPA-PSK), and WPA2-PSK keys.
		Supports the Advanced Encryption Standard (AES) encryption algorithm.
		Supports the TKIP and AES hybrid encryption algorithm.
	MAC address authentication	Supports the MAC address authentication whitelist.
		Supports the MAC address authentication blacklist.

Item	Description	
		Supports a maximum of 10 MAC address entries.
	Supports automatic transmission rate adjustment.	
	Station management	Supports station status queries.
		<ul style="list-style-type: none"> • Supports a maximum of 32 connected stations at 2.4 GHz. • Supports a maximum of 32 connected stations at 5 GHz.
IPv6/IPv4 dual stack	DHCPv6/v4 server and client	
	DNSv6/v4 server and client	
	Display IPv6/v4 WAN address	
HUAWEI Mobile WiFi App	View service provider's name, the roaming status and signal strength	
	View the data traffic usage and SMS	
	Manage the connected devices	
	Change CPE's SSID and password	
System requirements	Operating system: supports Windows XP SP3, Windows Vista SP1/SP2, Windows 7, Windows 8, Windows 8.1, Mac OS X 10.7, 10.8, and 10.9 with latest upgrades.	
	Hardware configuration: meets the configuration requirements of the operating system.	

3 Services and Applications

3.1 Data Services

By connecting to the E5186s-22a over a wireless or wired network, users can get access to high-speed Internet services.

The E5186s-22a can simultaneously set up wireless connections with 64 Wi-Fi devices and establish a local area network (LAN) by connecting to concentrators and switches.

3.1.1 Accessing the Internet Using an LTE, UMTS, or GSM Network

The E5186s-22a uses an LTE, UMTS, or GSM network to access the Internet.

Figure 3-1 Accessing the Internet using an LTE, UMTS, or GSM Network

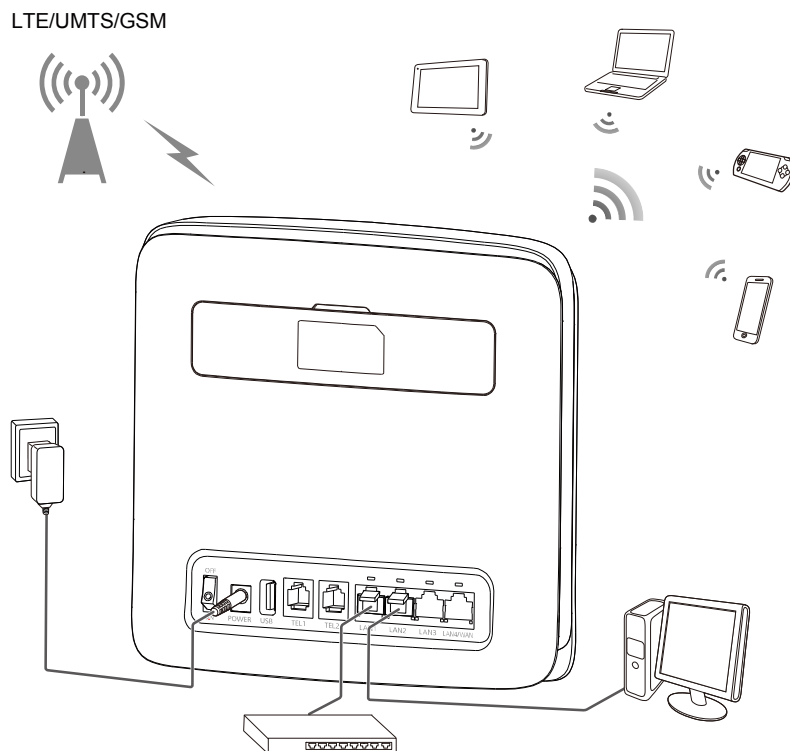

3.1.2 Accessing the Internet Using Ethernet

The LAN/WAN multiplexed port supports automatic identification of the LAN/WAN port in access mode, and automatic selection of accessing manners of ADSL domestic wideband, DHCP hotel wideband or static IP wideband. You can easily access the Internet using the Ethernet by connecting the LAN/WAN multiplexed port to the Ethernet with a network cable.

Figure 3-2 Accessing the Internet using Ethernet

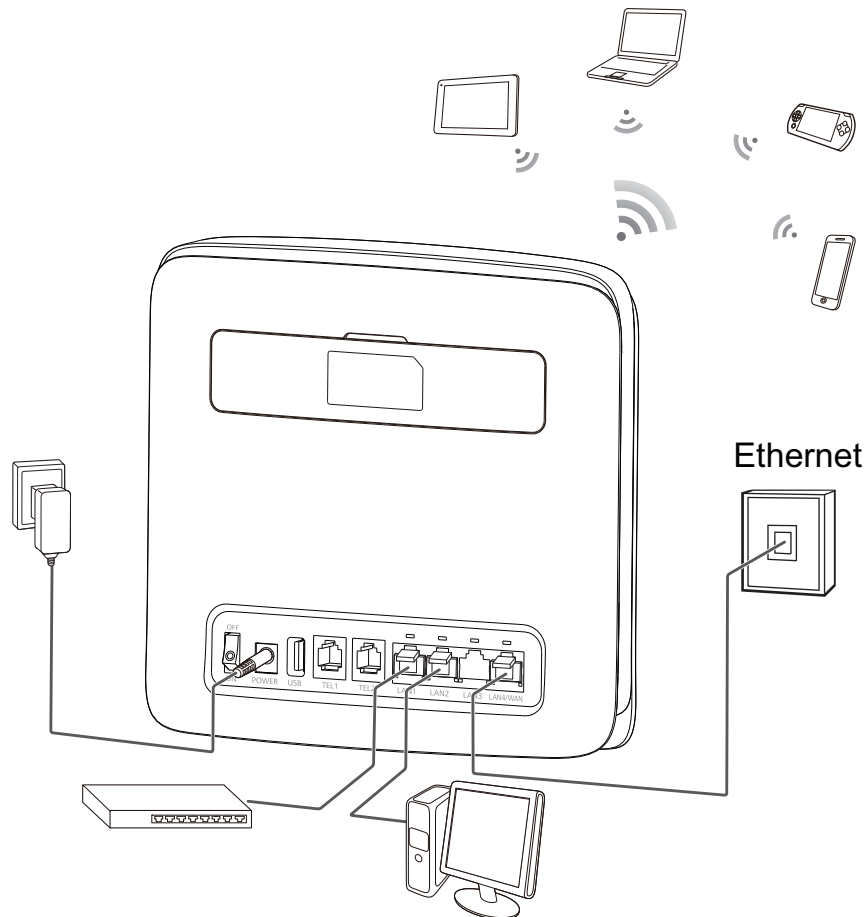

3.2 Voice Services

The E5186s-22a provides two telephone ports to which users can connect telephones to implement basic voice functions or connect fax machines to use fax services.

Figure 3-3 E5186s-22a connected to telephones

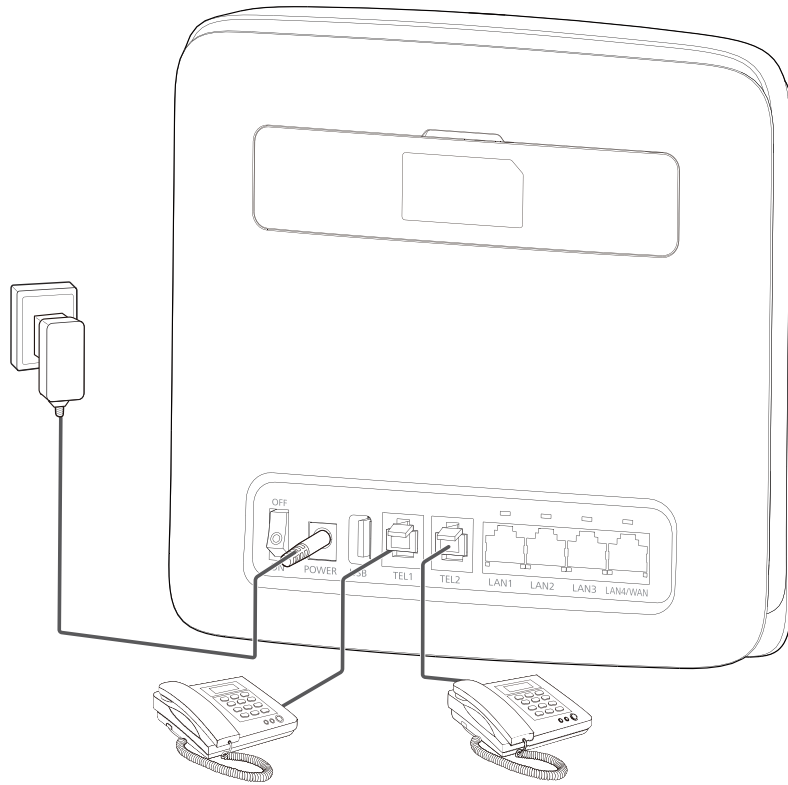
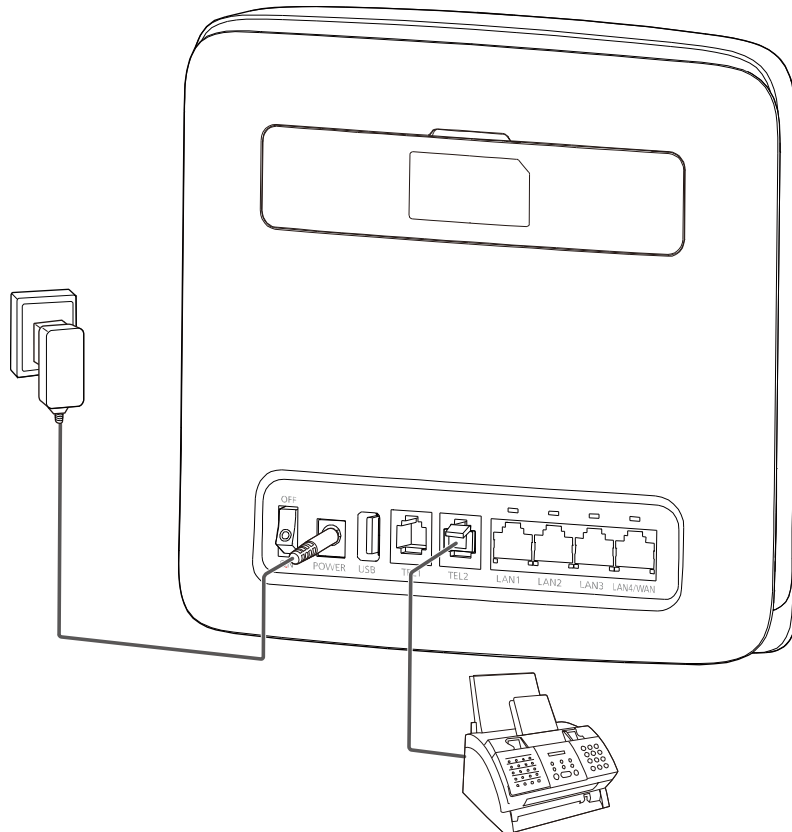

Figure 3-4 E5186s-22a connected to a fax machine



3.3 USB Sharing Services

With one USB port, users can connect a USB storage device to the USB port on the E5186s-22a to save and share files. Only USB storage devices in FAT and FAT32 formats are supported. Users can also connect a USB printer to the USB port on the E5186s-22a for printing services.

Figure 3-5 E5186s-22a connected to a USB storage device or USB printer

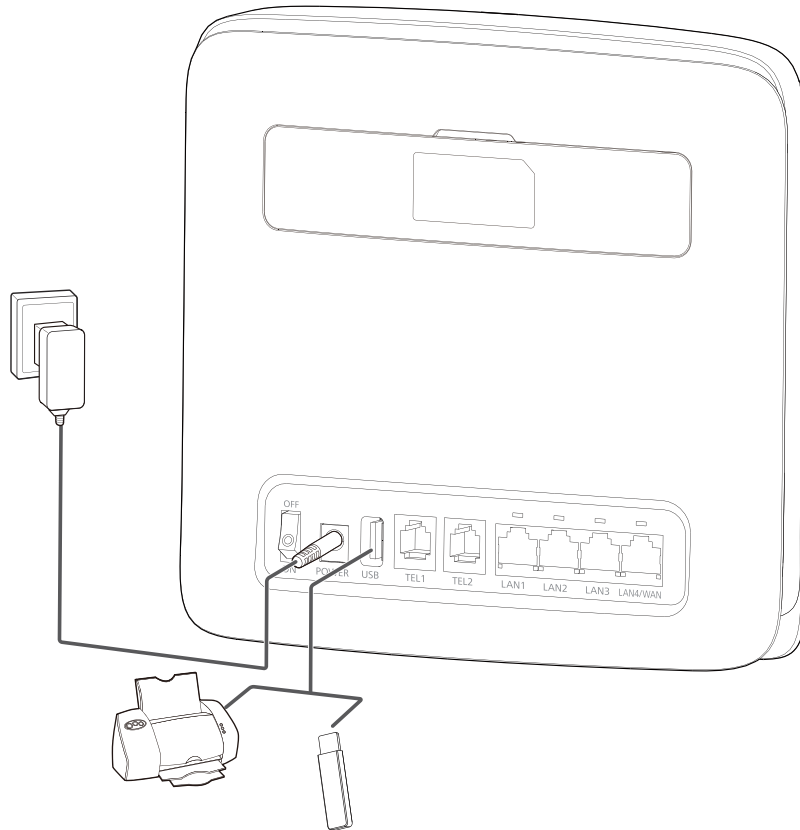

3.4 Security Services

The E5186s-22a offers security features, such as network firewalls, user authentication, and personal identification number (PIN) protection, to protect users from network security threats.

3.4.1 Firewall

The E5186s-22a has the following firewall functions:

- Firewall switch: Enable and disable the firewall.
- LAN MAC address filtering: Prevent specified MAC addresses on a LAN from accessing the network.
- LAN IP address filtering: Prevent specified IP addresses on a LAN from accessing the network.
- URL filtering: Prevent computers on a LAN from visiting specified URLs.

3.4.2 User Authentication

The E5186s-22a complies with the following user authentication protocols:

- WEP
- WPA-PSK
- WPA2-PSK

3.4.3 PIN Protection

If PIN protection is enabled, after the E5186s-22a restarts, users must enter the correct PIN each time they log in to the web management page.

3.5 Maintenance and Management

The E5186s-22a allows users to locally manage connected devices, complete network settings, and check the device status to ensure consistent performance.

4 System Architecture

4.1 System Architecture Diagram

Figure 4-1 shows the E5186s-22a system architecture.

Figure 4-1 E5186s-22a system architecture

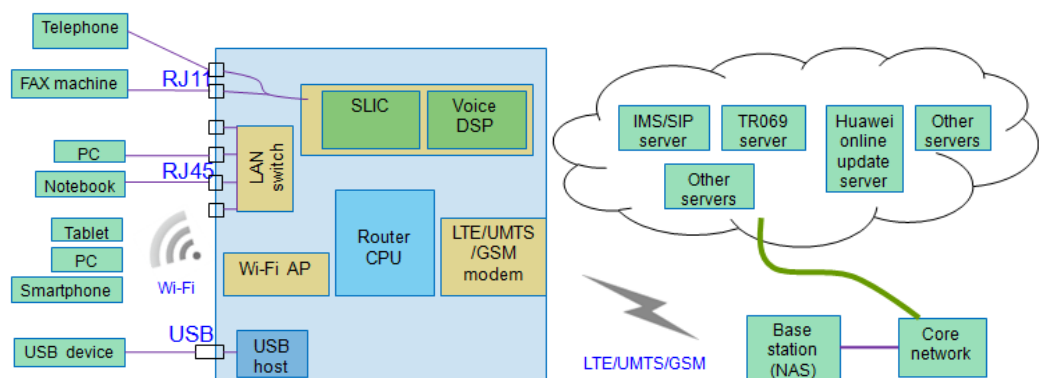

4.2 Functional Modules

- LTE/UMTS/GSM modem
Processes the access, management, and data transmission of LTE/DC-HSPA+/HSPA+/HSPA/UMTS/EDGE/GPRS/GSM.
- CPU
Transmits data and voices from the wireless metropolitan area network (WMAN) to the LAN.
- Subscriber Line Interface Circuit (SLIC)
Connects telephones or a fax to the E5186s-22a.
- LAN/WAN switch
Transmits data over Ethernet ports. When the Ethernet port works as a WAN port, it supports data transmitting.
- Wi-Fi access point (AP)
Enables wireless devices to connect to a LTE/UMTS/GSM network using Wi-Fi or related standards.

- USB 2.0 host port
Connects a USB storage device to the E5186s-22a.

5 Packing List

Table 5-1 lists the items included with the E5186s-22a.

Table 5-1 Items in the E5186s-22a package

Item	Quantity	Remarks
LTE CPE	1	Mandatory
Power adapter	1	Mandatory
Ethernet cable	1	Mandatory
Quick Start	1	Mandatory
Safety Information	1	Mandatory
Warranty Card	1	Optional
USB cable	1	Optional

A Acronyms and Abbreviations

Numerics

3G The Third Generation

A

AC Alternating Current

AES Advanced Encryption Standard

ALG Application Level Gateway

ARP Address Resolution Protocol

AP Access Point

APN Access Point Name

C

CPE Customer-Premises Equipment

CSFB circuit switched fallback

D

DC Direct Current

DC-HSPA+ Dual Carrier High Speed Packet Access Plus

DDR Double Data Rate

DHCP Dynamic Host Configuration Protocol

DL Down Link

DMZ demilitarized zone

DNS domain name service

E

EDGE Enhanced Data Rates for GSM Evolution

F

FDD frequency division duplex

G

GPRS General Packet Radio Service

GSM Global System for Mobile Communications

H

HSPA+ High Speed Packet Access Plus

HSPA High Speed Packet Access

HSDPA High Speed Downlink Packet Access

HSUPA High Speed Uplink Packet Access

I

ICMP Internet Control Message Protocol

IP Internet Protocol

L

LAN Local Area Network

LED Light Emitting Diode

LTE Long Term Evolution

M

MAC Media Access Control

MDI Medium Dependent Interface

MDIX Medium Dependent Interface Crossover

N

NAPT Network Address and Port Translation

NAT Network Address Translation

P

PIN Personal Identification Number

S

SDRAM Synchronous Dynamic Random Access Memory

SIM subscriber identity module

SIP Session Initiation Protocol

SMS Short Message Service

SOHO Small Office Home Office

SSID service set identifier

T

TDD	time division duplex
TKIP	Temporal Key Integrity Protocol
U	
UL	Up Link
UMTS	Universal Mobile Telecommunications System
UPnP	Universal Plug and Play
URL	Uniform Resource Locator
USB	Universal Serial Bus
W	
WAN	Wide Area Network
Wi-Fi	Wireless Fidelity
WLAN	Wireless Local Area Network
WPA-PSK	Wi-Fi Protected Access Pre-shared Key
WPS	Wi-Fi Protected Setup